

Dimensions

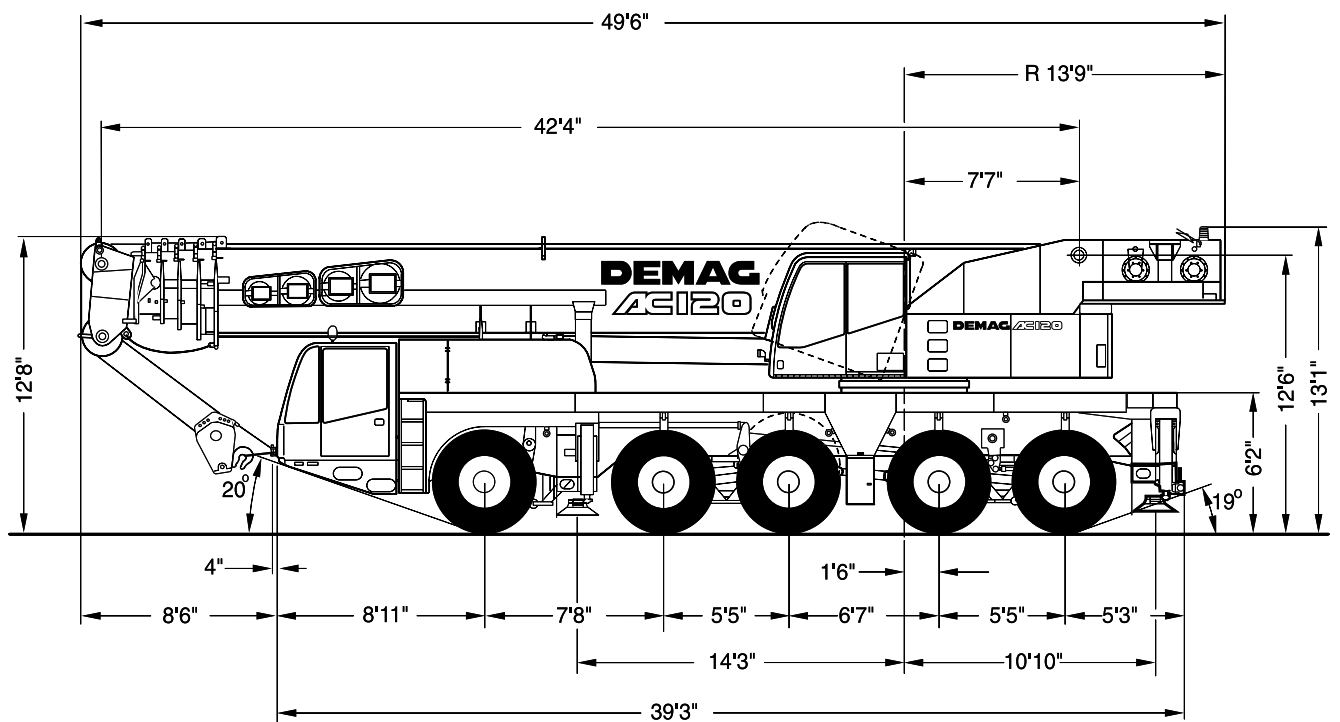

[MAIN MENU](#)

[CONTENTS](#)

Dimensions

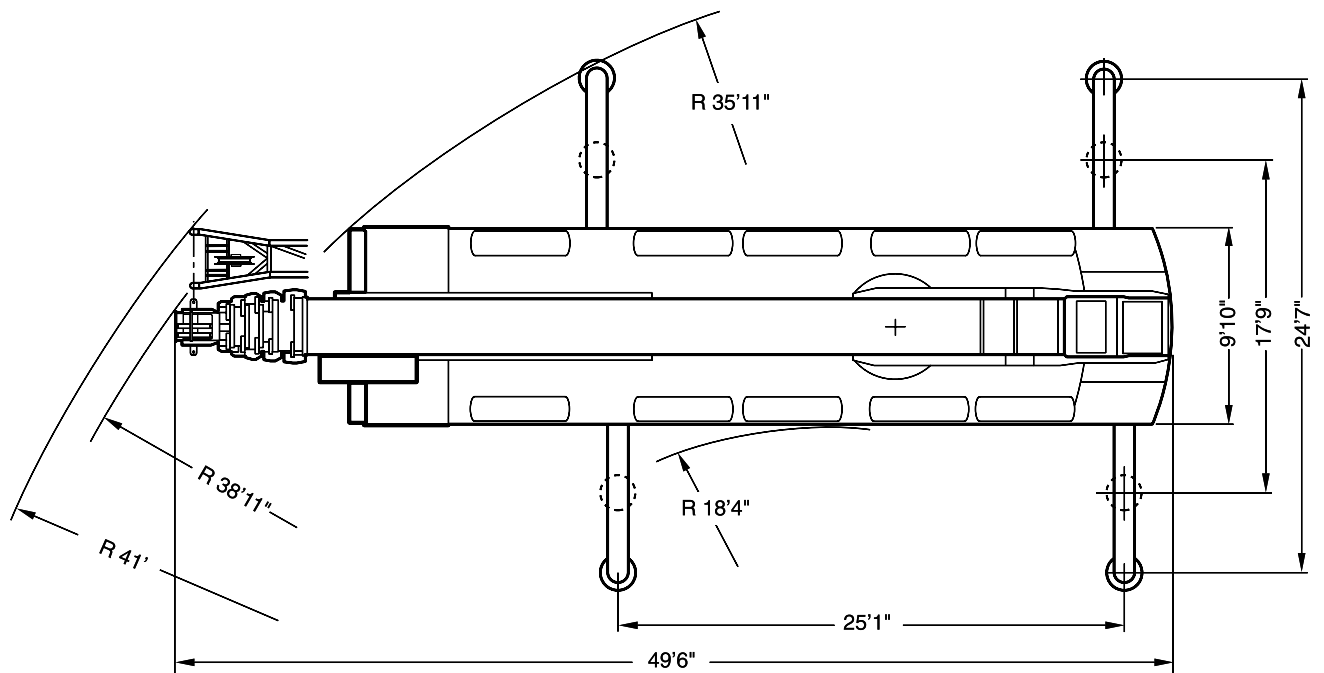
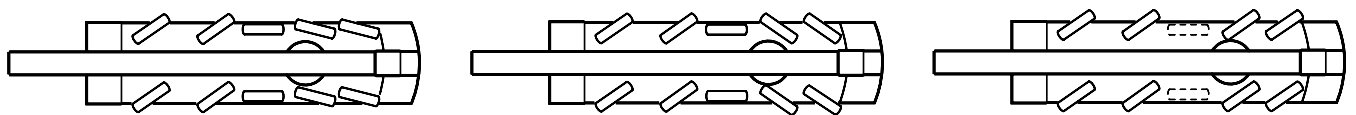

[MAIN MENU](#)

[CONTENTS](#)

Specifications

Axle loads

Basic machine with hook block type 32, 12,300 lb counterweight, tires 14.00 R 25		
Axles		5 x 26,460 lb
Total		132,300 lb

Working speeds (infinitely variable)

Mechanisms	Normal speed	High speed	Max. permissible line pull ¹⁾	Length of hoist rope
Hoist I	197 ft/min	361 ft/min	16,000 lb	787 ft
Hoist II	197 ft/min	361 ft/min	16,000 lb	787 ft
Slewing				max. 2 rpm
Telescoping speed	42-197 ft: 190 s			
Boom elevation	-1.5° - +80.5°: 55 s			

Carrier performance

Travel speed	
Forward	0 to 46/50 mph ³⁾
Reverse	0 to 4 mph
Gradeability in travel order	max. 60 %
Ground clearance	13 inches

Hook block/Single line hook

Type	Possible load ²⁾	Number of sheaves	Number of lines	Weight	„D“
125*)	132 t	9	18	2867 lb	6.6 ft
80	87 t	5	11	2051 lb	6.2 ft
63	55 t	3	7	1543 lb	6.2 ft
32	23 t	1	3	1213 lb	5.9 ft
8	8 t	Single line hook		551 lb	5.6 ft

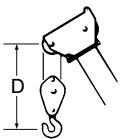

*) heavy-lift attachment is required, without heavy-lift attachment: capacity 86.4 tons (12 lines)

¹⁾ varies depending on national regulations

²⁾ varies depending on line pull permissible under different national regulations

³⁾ depending on tires

Working range main boom

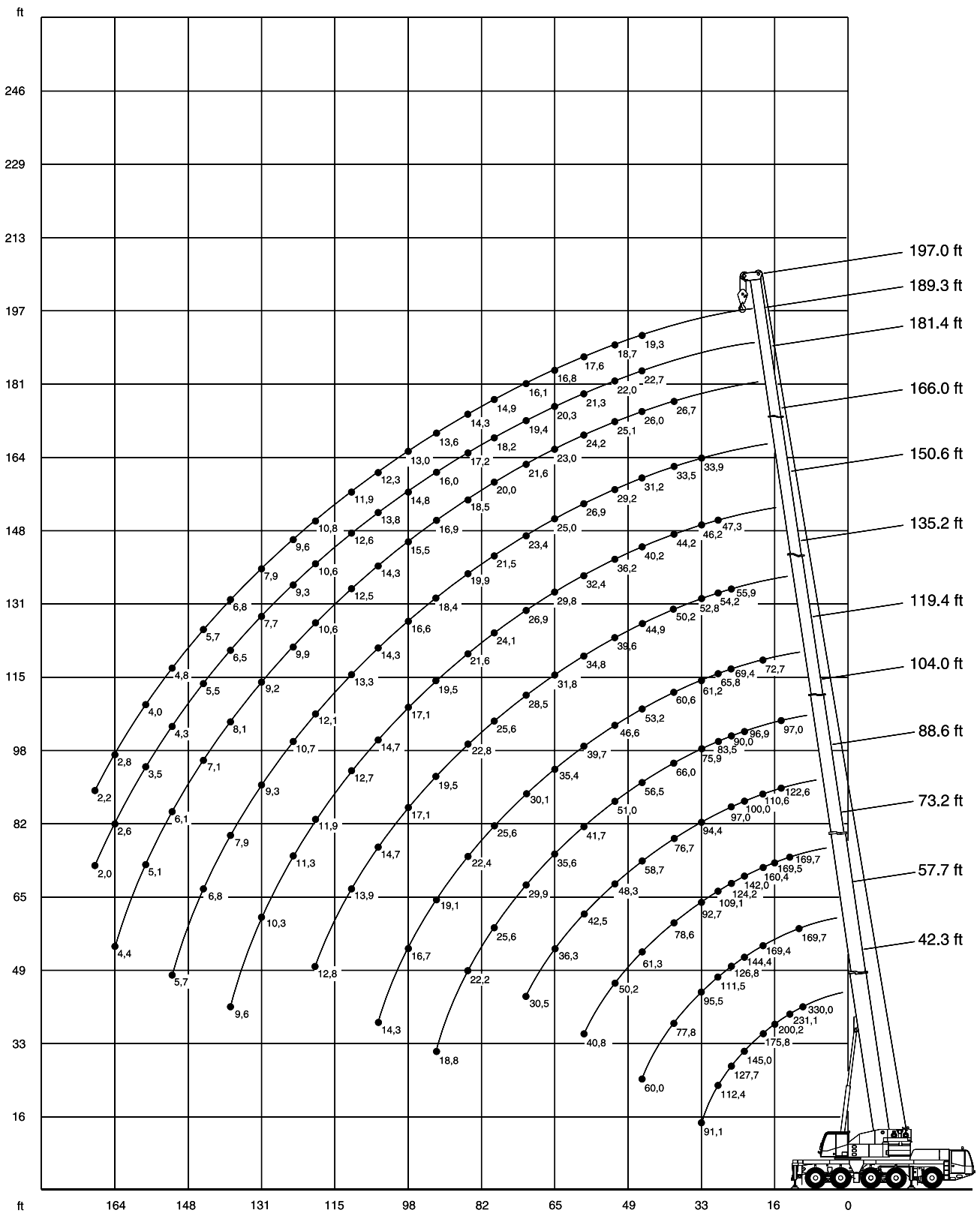

Lifting capacities main boom in 1,000 lb

83,800 lb

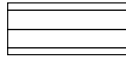

25'1" x 24'7" 360°

85%

Radius (ft)	Length of main boom (ft)																								
	42.3	57.7	73.2	73.2	88.6	88.6	88.6	104.0	104.3	119.1	119.4	119.4	135.2	135.2	135.2	150.6	150.6	150.6	166.0	166.0	181.4	181.8	189.3	197.0	
ft	1,000 lb																								
10	330.0*	-	-	-	-	-	-	-	-	-	-	-	-	-	-	-	-	-	-	-	-	-	-	-	-
10	300.0*	-	-	-	-	-	-	-	-	-	-	-	-	-	-	-	-	-	-	-	-	-	-	-	-
10	268.8	-	-	-	-	-	-	-	-	-	-	-	-	-	-	-	-	-	-	-	-	-	-	-	-
11	255.5	169.7	-	-	-	-	-	-	-	-	-	-	-	-	-	-	-	-	-	-	-	-	-	-	-
13	231.1	169.7	97.0	169.7	-	-	-	-	-	-	-	-	-	-	-	-	-	-	-	-	-	-	-	-	-
15	209.6	169.7	97.0	169.7	60.6	97.0	122.6	-	-	-	-	-	-	-	-	-	-	-	-	-	-	-	-	-	-
16	200.2	169.7	97.0	169.5	60.6	97.0	118.1	60.6	97.0	-	-	-	-	-	-	-	-	-	-	-	-	-	-	-	-
19	175.8	169.4	97.0	160.4	60.6	97.0	110.6	60.6	97.0	72.7	60.9	60.6	-	-	-	-	-	-	-	-	-	-	-	-	-
23	145.0	144.4	97.0	142.0	60.6	97.0	100.0	60.6	96.9	72.7	58.8	60.6	-	-	-	-	-	-	-	-	-	-	-	-	-
26	127.7	126.8	97.0	124.2	60.6	97.0	92.7	60.6	90.0	69.4	56.8	60.6	36.3	53.3	55.9	-	-	-	-	-	-	-	-	-	-
29	112.4	111.5	97.0	109.1	60.6	97.0	86.0	60.6	83.5	65.8	54.6	60.6	36.3	50.5	54.2	32.5	43.0	47.3	-	-	-	-	-	-	-
33	91.1	95.5	91.9	92.7	60.5	94.4	77.7	60.5	75.9	61.2	51.9	60.6	35.4	46.8	52.8	31.4	41.1	46.2	31.0	33.9	-	-	-	-	-
39	-	77.8	78.6	75.3	57.5	76.7	67.0	58.7	66.0	54.6	48.7	60.6	32.5	42.3	50.2	28.8	37.6	44.2	28.3	33.5	21.6	26.7	-	-	-
46	-	60.0	61.3	57.1	52.4	58.7	56.0	54.8	56.5	47.5	45.3	53.2	29.2	38.1	44.9	25.9	34.3	40.2	25.7	31.2	20.7	26.0	22.7	19.3	-
52	-	-	50.2	46.3	48.3	47.8	45.4	51.0	47.2	41.7	42.3	46.6	26.6	35.0	39.6	23.9	31.7	36.2	23.9	29.2	19.7	25.1	22.0	18.7	-
59	-	-	40.8	36.8	42.5	38.4	36.0	41.7	37.9	35.9	38.8	39.7	24.0	31.9	34.8	21.8	28.9	32.4	22.0	26.9	18.5	24.2	21.3	17.6	-
65	-	-	-	-	36.3	32.3	29.9	35.6	31.9	31.5	35.4	33.8	22.2	29.7	31.8	20.2	26.8	29.8	20.8	25.0	17.3	23.0	20.3	16.8	-
72	-	-	-	-	30.5	26.6	24.1	29.9	26.1	25.9	30.1	28.1	20.3	27.6	28.5	18.7	24.7	26.9	19.4	23.4	16.3	21.6	19.4	16.1	-
79	-	-	-	-	-	-	-	25.6	21.4	21.2	25.6	23.4	18.9	25.6	23.8	17.3	22.8	24.1	18.2	21.5	14.9	20.0	18.2	14.9	-
85	-	-	-	-	-	-	-	22.2	18.0	17.8	22.4	20.0	17.6	22.8	20.4	16.3	21.6	21.5	17.2	19.9	14.1	18.5	17.2	14.3	-
92	-	-	-	-	-	-	-	18.8	14.9	14.5	19.1	16.7	16.5	19.5	17.1	15.1	19.5	18.2	16.0	18.4	13.2	16.9	16.0	13.6	-
98	-	-	-	-	-	-	-	-	12.2	16.7	14.2	15.5	17.1	14.9	14.3	17.1	15.6	15.2	16.6	12.6	15.5	14.8	13.0	-	-
105	-	-	-	-	-	-	-	-	9.9	14.3	11.9	14.5	14.7	12.3	13.6	14.7	13.2	14.3	14.1	12.1	14.3	13.8	12.3	-	-
111	-	-	-	-	-	-	-	-	-	-	-	13.9	12.9	10.5	12.6	12.7	11.6	13.3	12.2	11.5	12.5	12.6	11.9	-	-
118	-	-	-	-	-	-	-	-	-	-	-	-	12.8	11.2	8.8	11.9	10.8	9.7	12.1	10.3	10.5	10.6	10.6	10.8	-
124	-	-	-	-	-	-	-	-	-	-	-	-	-	-	-	11.3	9.6	8.1	10.7	9.1	9.9	9.1	9.3	9.6	-
131	-	-	-	-	-	-	-	-	-	-	-	-	-	-	-	10.3	8.2	6.8	9.3	7.5	9.2	7.7	7.7	7.9	-
138	-	-	-	-	-	-	-	-	-	-	-	-	-	-	-	9.6	7.0	5.4	7.9	6.3	8.1	6.5	6.5	6.8	-
144	-	-	-	-	-	-	-	-	-	-	-	-	-	-	-	-	-	-	6.8	5.1	7.1	5.3	5.5	5.7	-
151	-	-	-	-	-	-	-	-	-	-	-	-	-	-	-	-	-	-	5.7	4.1	6.1	4.3	4.3	4.8	-
157	-	-	-	-	-	-	-	-	-	-	-	-	-	-	-	-	-	-	-	-	5.1	3.3	3.5	4.0	-
164	-	-	-	-	-	-	-	-	-	-	-	-	-	-	-	-	-	-	-	-	4.4	2.6	2.6	2.8	-
170	-	-	-	-	-	-	-	-	-	-	-	-	-	-	-	-	-	-	-	-	-	-	2.0	2.2	-

Boom extension sequence %

Tele 1	0	0	0	50	30	50	75	40	67	83	50	70	30	60	80	20	70	85	65	90	50	95	100	100
Tele 2	0	50	50	50	30	50	75	40	67	83	50	70	30	60	80	60	70	85	65	90	100	95	100	100
Tele 3	0	0	50	0	30	50	0	60	67	83	70	70	80	60	70	90	70	70	90	70	100	95	92	100
Tele 4	0	0	0	0	30	0	0	30	0	0	40	20	80	60	35	90	70	55	90	75	100	83	92	100
Tele 5	0	0	0	0	30	0	0	30	0	0	40	20	80	60	35	90	70	55	90	75	100	83	92	100

*) over rear

MAIN MENU

CONTENTS

Lifting capacities main boom in 1,000 lb

61,700 lb

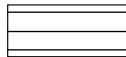

25'1" x 24'7" 360°

85%

Radius (ft)	Length of main boom (ft)																								
	42.3	57.7	73.2	73.2	88.6	88.6	88.6	104.0	104.3	119.1	119.4	119.4	135.2	135.2	135.2	150.6	150.6	150.6	166.0	166.0	181.4	181.8	189.3	197.0	
ft	1,000 lb																								
10	300.0*	-	-	-	-	-	-	-	-	-	-	-	-	-	-	-	-	-	-	-	-	-	-	-	-
10	267.8	-	-	-	-	-	-	-	-	-	-	-	-	-	-	-	-	-	-	-	-	-	-	-	-
11	253.7	169.7	-	-	-	-	-	-	-	-	-	-	-	-	-	-	-	-	-	-	-	-	-	-	-
13	227.9	169.7	97.0	169.7	-	-	-	-	-	-	-	-	-	-	-	-	-	-	-	-	-	-	-	-	-
15	206.8	169.7	97.0	169.7	60.6	97.0	122.6	-	-	-	-	-	-	-	-	-	-	-	-	-	-	-	-	-	-
16	197.7	169.7	97.0	169.5	60.6	97.0	118.1	60.6	97.0	-	-	-	-	-	-	-	-	-	-	-	-	-	-	-	-
19	168.5	162.7	97.0	160.4	60.6	97.0	110.6	60.6	97.0	72.7	60.9	60.6	-	-	-	-	-	-	-	-	-	-	-	-	-
23	136.9	135.8	97.0	133.1	60.6	97.0	100.0	60.6	96.9	72.7	58.8	60.6	-	-	-	-	-	-	-	-	-	-	-	-	-
26	118.3	117.6	97.0	115.0	60.6	97.0	92.7	60.6	90.0	69.4	56.8	60.6	36.3	53.3	55.9	-	-	-	-	-	-	-	-	-	-
29	104.0	103.2	97.0	100.7	60.6	97.0	86.0	60.6	83.5	65.8	54.6	60.6	36.3	50.5	54.2	32.5	43.0	47.3	-	-	-	-	-	-	-
33	87.1	85.9	87.5	82.4	60.5	84.6	77.4	60.5	75.8	61.2	51.9	60.6	35.4	46.8	52.8	31.4	41.1	46.2	31.0	33.9	-	-	-	-	-
39	-	64.3	65.9	61.2	57.5	63.2	59.9	58.7	62.1	54.6	48.7	60.6	32.5	42.3	50.2	28.8	37.6	44.2	28.3	33.5	21.6	26.7	-	-	-
46	-	48.3	49.7	45.3	51.2	46.8	44.2	50.8	46.4	46.1	45.3	48.6	29.2	38.1	44.9	25.9	34.3	40.2	25.7	31.2	20.7	26.0	22.7	19.3	-
52	-	-	40.2	36.2	41.9	37.7	35.3	41.5	37.3	37.1	41.3	39.3	26.6	35.0	39.6	23.9	31.7	36.2	23.9	29.2	19.7	25.1	22.0	18.7	-
59	-	-	32.2	28.2	33.7	29.6	27.1	33.3	29.3	29.1	33.5	31.1	24.0	31.9	31.8	21.8	28.9	32.4	22.0	26.9	18.5	24.2	21.3	17.6	-
65	-	-	-	-	28.7	24.3	21.7	27.8	23.9	23.5	28.5	26.0	22.2	28.7	26.5	20.2	26.8	27.4	20.8	25.0	17.3	23.0	20.3	16.8	-
72	-	-	-	-	23.7	19.3	16.6	22.8	18.6	18.4	23.4	20.8	20.3	23.9	21.5	18.7	23.8	22.3	19.4	23.4	16.3	21.6	19.4	16.1	-
79	-	-	-	-	-	-	-	18.8	14.6	14.4	19.0	16.6	18.9	19.7	17.2	17.3	19.7	18.3	18.2	19.2	14.9	19.4	18.2	14.9	-
85	-	-	-	-	-	-	-	16.0	11.8	11.6	16.2	13.8	17.6	16.8	14.4	16.3	16.8	15.1	17.2	16.2	14.1	16.4	16.6	14.3	-
92	-	-	-	-	-	-	-	13.1	9.2	8.7	13.1	10.7	16.4	14.0	11.6	15.1	13.8	12.3	15.1	13.1	13.2	13.6	13.8	13.6	-
98	-	-	-	-	-	-	-	-	6.9	11.3	8.9	14.4	11.8	9.4	14.3	11.8	10.2	12.9	11.3	12.6	11.6	11.6	12.0	-	-
105	-	-	-	-	-	-	-	-	4.8	9.2	7.0	12.3	9.6	7.4	12.5	9.6	8.1	10.8	9.2	11.2	9.4	9.4	9.6	-	-
111	-	-	-	-	-	-	-	-	-	-	-	10.7	8.0	5.8	10.9	8.0	6.7	9.3	7.6	9.6	7.8	7.8	8.0	-	-
118	-	-	-	-	-	-	-	-	-	-	-	-	9.2	6.6	4.4	9.5	6.6	4.8	7.7	6.1	7.9	6.4	6.4	6.6	-
124	-	-	-	-	-	-	-	-	-	-	-	-	-	-	-	8.0	5.4	3.4	6.7	4.7	6.9	5.0	5.2	5.4	-
131	-	-	-	-	-	-	-	-	-	-	-	-	-	-	-	6.8	4.2	2.4	5.3	3.5	5.5	3.5	4.0	4.2	-
138	-	-	-	-	-	-	-	-	-	-	-	-	-	-	-	5.6	3.0	-	4.3	2.6	4.5	2.6	2.8	3.0	-
144	-	-	-	-	-	-	-	-	-	-	-	-	-	-	-	-	-	-	3.3	-	3.5	-	2.0	2.2	-
151	-	-	-	-	-	-	-	-	-	-	-	-	-	-	-	-	-	-	-	2.4	-	2.6	-	-	-
157	-	-	-	-	-	-	-	-	-	-	-	-	-	-	-	-	-	-	-	-	2.0	-	-	-	-

Boom extension sequence %

Tele 1	0	0	0	50	30	50	75	40	67	83	50	70	30	60	80	20	70	85	65	90	50	95	100	100
Tele 2	0	50	50	50	30	50	75	40	67	83	50	70	30	60	80	60	70	85	65	90	100	95	100	100
Tele 3	0	0	50	0	30	50	0	60	67	83	70	70	80	60	70	90	70	70	90	70	100	95	92	100
Tele 4	0	0	0	0	30	0	0	30	0	0	40	20	80	60	35	90	70	55	90	75	100	83	92	100
Tele 5	0	0	0	0	30	0	0	30	0	0	40	20	80	60	35	90	70	55	90	75	100	83	92	100

*) over rear

MAIN MENU

CONTENTS

Lifting capacities main boom in 1,000 lb

37,000 lb

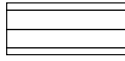

25'1" x 24'7" 360°

85%

Radius (ft)	Length of main boom (ft)																								
	42.3	57.7	73.2	73.2	88.6	88.6	88.6	104.0	104.3	119.1	119.4	119.4	135.2	135.2	135.2	150.6	150.6	150.6	166.0	166.0	181.4	181.8	189.3	197.0	
ft	1,000 lb																								
10	264.8	-	-	-	-	-	-	-	-	-	-	-	-	-	-	-	-	-	-	-	-	-	-	-	-
11	250.2	169.7	-	-	-	-	-	-	-	-	-	-	-	-	-	-	-	-	-	-	-	-	-	-	-
13	224.6	169.7	97.0	169.7	-	-	-	-	-	-	-	-	-	-	-	-	-	-	-	-	-	-	-	-	-
15	200.7	169.7	97.0	169.7	60.6	97.0	122.6	-	-	-	-	-	-	-	-	-	-	-	-	-	-	-	-	-	-
16	188.4	169.7	97.0	169.5	60.6	97.0	118.1	60.6	97.0	-	-	-	-	-	-	-	-	-	-	-	-	-	-	-	-
19	157.4	153.8	97.0	151.5	60.6	97.0	110.6	60.6	97.0	72.7	60.9	60.6	-	-	-	-	-	-	-	-	-	-	-	-	-
23	125.2	124.3	97.0	115.7	60.6	96.9	99.9	60.6	96.8	72.7	58.8	60.6	-	-	-	-	-	-	-	-	-	-	-	-	-
26	104.4	103.3	97.0	96.3	60.6	91.0	88.0	60.6	85.5	69.4	56.8	60.6	36.3	53.3	55.9	-	-	-	-	-	-	-	-	-	-
29	85.5	84.2	84.9	80.0	60.6	78.5	75.2	60.6	73.9	65.8	54.6	60.6	36.3	50.5	54.2	32.5	43.0	47.3	-	-	-	-	-	-	-
33	66.8	65.8	67.5	62.5	60.3	64.4	61.6	60.3	61.0	57.7	51.9	60.2	35.4	46.8	52.6	31.4	41.1	46.2	31.0	33.9	-	-	-	-	-
39	-	48.6	50.0	45.1	51.4	47.1	44.2	51.0	46.5	44.4	48.7	47.1	32.5	42.3	45.6	28.8	37.6	44.2	28.3	33.5	21.6	26.7	-	-	-
46	-	34.9	36.5	31.8	38.2	33.6	30.9	37.8	33.2	33.2	38.2	35.6	29.2	38.0	35.4	25.9	34.3	34.9	25.7	31.2	20.7	26.0	22.7	19.3	-
52	-	-	28.8	24.2	30.4	26.1	23.1	29.9	25.3	25.1	30.2	27.7	26.6	31.0	28.5	23.9	30.3	28.9	23.9	28.6	19.7	25.1	22.0	18.7	-
59	-	-	22.1	17.4	23.8	19.2	16.3	23.4	18.5	18.3	23.6	20.9	24.0	24.0	21.6	21.8	24.3	22.5	22.0	23.4	18.5	22.7	21.3	17.6	-
65	-	-	-	-	19.4	14.7	12.1	18.7	14.3	14.1	19.1	16.5	22.2	19.6	17.2	20.2	19.6	18.0	20.8	19.1	17.3	19.1	18.9	16.8	-
72	-	-	-	-	15.1	10.6	8.2	14.6	10.2	10.0	14.8	12.2	18.4	15.3	12.8	18.5	15.3	13.9	16.8	14.8	16.3	15.0	15.3	15.4	-
79	-	-	-	-	-	-	-	11.3	7.1	6.7	11.5	9.1	14.8	12.2	9.6	15.1	12.2	10.4	13.5	11.5	13.7	11.8	12.0	12.2	-
85	-	-	-	-	-	-	-	9.1	4.9	4.5	9.3	6.9	12.6	9.8	7.3	12.6	9.8	8.2	11.3	9.3	11.5	9.5	9.6	10.0	-
92	-	-	-	-	-	-	-	7.0	2.8	2.3	7.0	4.5	10.3	7.4	5.2	10.3	7.4	6.1	8.9	7.0	9.2	7.2	7.4	7.6	-
98	-	-	-	-	-	-	-	-	-	-	5.4	2.9	8.5	5.8	3.4	8.9	5.8	4.5	7.1	5.4	7.4	5.6	5.6	5.8	-
105	-	-	-	-	-	-	-	-	-	-	3.9	-	7.0	4.1	1.9	7.0	4.4	2.8	5.5	3.5	5.7	3.9	4.1	4.4	-
111	-	-	-	-	-	-	-	-	-	-	-	-	5.6	2.7	-	5.8	2.9	-	4.3	2.5	4.5	2.7	2.7	2.9	-
118	-	-	-	-	-	-	-	-	-	-	-	-	4.4	1.7	-	4.6	-	-	2.8	-	3.1	-	-	-	-
124	-	-	-	-	-	-	-	-	-	-	-	-	-	-	-	3.4	-	-	2.0	-	2.2	-	-	-	-
131	-	-	-	-	-	-	-	-	-	-	-	-	-	-	-	2.6	-	-	-	-	-	-	-	-	-
138	-	-	-	-	-	-	-	-	-	-	-	-	-	-	-	1.9	-	-	-	-	-	-	-	-	-

Boom extension sequence %

Tele 1	0	0	0	50	30	50	75	40	67	83	50	70	30	60	80	20	70	85	65	90	50	95	100	100
Tele 2	0	50	50	50	30	50	75	40	67	83	50	70	30	60	80	60	70	85	65	90	100	95	100	100
Tele 3	0	0	50	0	30	50	0	60	67	83	70	70	80	60	70	90	70	70	90	70	100	95	92	100
Tele 4	0	0	0	0	30	0	0	30	0	0	40	20	80	60	35	90	70	55	90	75	100	83	92	100
Tele 5	0	0	0	0	30	0	0	30	0	0	40	20	80	60	35	90	70	55	90	75	100	83	92	100

Lifting capacities main boom in 1,000 lb

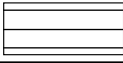

12,300 lb  **25'1" x 24'7"** **360°** **85%**

Radius (ft)	Length of main boom (ft)																								
	42.3	57.7	73.2	73.2	88.6	88.6	88.6	104.0	104.3	119.1	119.4	119.4	135.2	135.2	135.2	150.6	150.6	150.6	166.0	166.0	181.4	181.8	189.3	197.0	
ft	1,000 lb																								
10	260.9	-	-	-	-	-	-	-	-	-	-	-	-	-	-	-	-	-	-	-	-	-	-	-	-
11	246.5	169.7	-	-	-	-	-	-	-	-	-	-	-	-	-	-	-	-	-	-	-	-	-	-	-
13	217.0	169.7	97.0	169.7	-	-	-	-	-	-	-	-	-	-	-	-	-	-	-	-	-	-	-	-	-
15	188.6	169.5	97.0	165.9	60.6	97.0	122.6	-	-	-	-	-	-	-	-	-	-	-	-	-	-	-	-	-	-
16	175.5	168.4	97.0	149.9	60.6	97.0	118.1	60.6	97.7	-	-	-	-	-	-	-	-	-	-	-	-	-	-	-	-
19	144.2	132.4	97.0	114.2	60.6	97.0	100.0	60.6	92.4	74.1	60.9	60.6	-	-	-	-	-	-	-	-	-	-	-	-	-
23	98.3	95.0	89.3	82.4	60.6	78.1	74.1	60.6	71.7	66.0	58.8	60.5	-	-	-	-	-	-	-	-	-	-	-	-	-
26	76.3	74.6	73.2	66.5	60.6	63.9	60.0	60.6	58.8	54.5	56.8	56.9	36.3	53.4	54.6	-	-	-	-	-	-	-	-	-	-
29	60.4	59.1	60.5	54.5	58.0	53.2	49.6	54.5	49.2	45.8	51.6	48.5	36.3	49.4	46.8	32.5	43.2	45.3	-	-	-	-	-	-	-
33	45.3	44.5	46.0	40.7	48.0	42.3	38.6	44.8	39.1	36.5	42.8	39.3	35.4	41.3	38.0	31.4	39.3	37.6	31.0	33.7	-	-	-	-	-
39	-	30.8	32.5	27.2	34.5	29.6	26.3	33.9	28.6	26.6	32.6	29.2	32.5	31.8	28.5	28.8	30.3	28.5	28.3	27.9	21.6	27.0	-	-	-
46	-	20.1	21.9	16.6	24.1	18.8	15.3	23.7	18.2	17.7	23.9	20.8	27.2	23.7	20.6	25.9	22.6	20.8	23.3	20.8	20.6	20.0	19.7	19.3	-
52	-	-	15.7	10.6	17.9	12.6	9.7	17.2	12.1	11.9	17.7	14.6	21.6	18.3	15.4	21.5	17.8	15.8	18.6	16.2	17.8	15.5	15.5	15.5	-
59	-	-	10.6	5.7	12.3	7.5	4.8	11.9	7.0	6.8	12.1	9.5	16.1	12.8	10.1	16.3	12.8	11.2	14.1	11.9	14.1	11.7	11.7	11.7	-
65	-	-	-	-	9.1	4.5	-	8.5	3.8	3.6	8.7	6.0	12.6	9.5	6.9	12.7	9.5	7.8	10.9	9.1	10.9	8.6	8.6	8.6	-
72	-	-	-	-	6.2	-	-	5.1	-	-	5.8	3.1	9.3	6.4	3.6	9.5	6.4	4.9	7.7	5.8	8.0	5.8	5.8	5.8	-
79	-	-	-	-	-	-	-	2.7	-	-	3.2	-	6.9	4.1	-	6.9	4.1	2.3	5.2	3.4	5.6	3.4	3.4	3.4	-
85	-	-	-	-	-	-	-	-	-	-	-	-	5.1	2.2	-	5.3	-	-	3.6	-	4.0	-	-	-	-
92	-	-	-	-	-	-	-	-	-	-	-	-	3.2	-	-	3.5	-	-	-	-	2.3	-	-	-	-
98	-	-	-	-	-	-	-	-	-	-	-	-	2.2	-	-	2.2	-	-	-	-	-	-	-	-	-

Boom extension sequence %

Tele 1	0	0	0	50	30	50	75	40	67	83	50	70	30	60	80	20	70	85	65	90	50	95	100	100
Tele 2	0	50	50	50	30	50	75	40	67	83	50	70	30	60	80	60	70	85	65	90	100	95	100	100
Tele 3	0	0	50	0	30	50	0	60	67	83	70	70	80	60	70	90	70	90	70	100	100	95	92	100
Tele 4	0	0	0	0	30	0	0	30	0	0	40	20	80	60	35	90	70	55	90	75	100	83	92	100
Tele 5	0	0	0	0	30	0	0	30	0	0	40	20	80	60	35	90	70	55	90	75	100	83	92	100

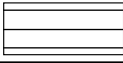
Lifting capacities main boom in 1,000 lb

0 lb   **25'1" x 24'7"** **360°** **85%**

Radius	Length of main boom (ft)						
	42.3 ft	57.7 ft	73.2 ft	73.2 ft	88.6 ft	88.6 ft	88.6 ft
ft	1,000 lb						
10	253.0	-	-	-	-	-	-
11	242.8	169.7	-	-	-	-	-
13	211.1	169.7	97.0	171.9	-	-	-
15	181.3	165.2	97.0	137.7	60.6	97.0	119.6
16	168.0	146.9	97.0	123.6	60.6	97.0	108.0
19	116.4	109.2	93.6	91.7	60.6	83.0	80.7
23	72.1	70.7	70.3	63.3	60.5	60.2	56.0
26	53.9	52.6	54.4	48.4	54.5	48.5	44.3
29	41.9	40.7	42.5	37.0	44.7	38.9	35.1
33	30.8	29.6	31.4	26.1	33.6	28.3	25.2
39	-	19.1	20.5	15.8	22.7	17.8	14.9
46	-	11.8	12.9	8.7	14.7	10.3	7.4
52	-	-	8.7	-	10.4	5.8	-
59	-	-	4.8	-	6.8	-	-

Boom extension sequence %

Tele 1	0	0	0	50	30	50	75
Tele 2	0	50	50	50	30	50	75
Tele 3	0	0	50	0	30	50	0
Tele 4	0	0	0	0	30	0	0
Tele 5	0	0	0	0	30	0	0

[MAIN MENU](#)

[CONTENTS](#)

Lifting capacities main boom in 1,000 lb

Special boom extension sequence

37,000 lb

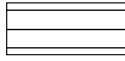

25'1" x 24'7"

360°

85%

Radius	Length of main boom (ft)					
	88.6 ft	104.3 ft	119.1 ft	135.2 ft	150.6 ft	166.0 ft
ft	1,000 lb					
15	55.7	-	-	-	-	-
16	55.7	56.3	-	-	-	-
19	52.8	51.9	38.8	-	-	-
23	48.9	46.4	38.7	-	-	-
26	46.2	43.0	36.3	21.8	-	-
29	43.6	39.8	34.1	21.8	21.8	-
33	40.6	36.2	31.4	21.8	21.8	21.8
39	36.6	31.8	28.1	21.8	21.8	21.8
46	32.8	27.9	25.1	21.5	21.8	21.5
52	29.9	25.3	22.8	19.5	20.3	19.9
59	27.1	22.9	20.9	17.8	18.9	18.5
65	23.7	21.3	19.1	16.6	17.5	17.1
72	19.7	19.6	17.4	15.2	16.3	15.9
79	-	17.0	16.0	14.0	14.9	14.7
85	-	14.6	14.8	12.8	13.9	13.0
92	-	12.3	12.7	11.6	11.8	10.7
98	-	-	11.3	10.6	10.0	9.3
105	-	-	9.4	9.6	8.3	7.4
111	-	-	-	8.4	7.1	6.4
118	-	-	-	7.2	5.7	5.0
124	-	-	-	-	4.9	4.0
131	-	-	-	-	4.0	2.9
138	-	-	-	-	3.0	2.1

Boom extension sequence %



Tele 1	0	0	0	0	0	0
Tele 2	0	0	0	0	50	100
Tele 3	50	67	83	100	100	100
Tele 4	50	67	83	100	100	100
Tele 5	50	67	83	100	100	100

[MAIN MENU](#)

[CONTENTS](#)

Lifting capacities main boom in 1,000 lb

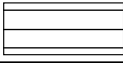
Special boom extension sequence

12,300 lb   25'1" x 24'7" 360° 85%

Radius	Length of main boom (ft)					
	88.6 ft	104.3 ft	119.1 ft	135.2 ft	150.6 ft	166.0 ft
ft	1,000 lb					
15	55.7	-	-	-	-	-
16	55.7	56.3	-	-	-	-
19	52.8	51.9	38.8	-	-	-
23	48.9	46.4	38.7	-	-	-
26	46.2	43.0	36.3	21.8	-	-
29	43.6	39.8	34.1	21.8	21.8	-
33	40.6	36.2	31.4	21.8	21.8	21.8
39	36.6	31.8	28.1	21.8	21.8	21.8
46	29.2	27.9	25.1	21.5	21.8	21.5
52	23.0	23.7	22.8	19.5	20.3	19.9
59	17.6	18.5	18.9	17.8	17.8	16.7
65	14.2	14.9	15.3	15.6	14.4	13.3
72	10.8	11.7	12.2	12.4	11.3	10.2
79	-	9.1	9.6	9.8	8.7	7.6
85	-	7.3	7.8	8.0	6.9	5.8
92	-	5.4	6.1	6.3	5.0	4.1
98	-	-	4.9	5.1	3.6	2.9
105	-	-	3.5	3.9	2.6	-
111	-	-	-	2.9	-	-

Boom extension sequence %

Tele 1	0	0	0	0	0	0
Tele 2	0	0	0	0	50	100
Tele 3	50	67	83	100	100	100
Tele 4	50	67	83	100	100	100
Tele 5	50	67	83	100	100	100

[MAIN MENU](#)

[CONTENTS](#)

Lifting capacities main boom in 1,000 lb

83,800 lb

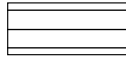

25'1" x 17'9" 360°

85%

Radius (ft)	Length of main boom (ft)																							
	42.3	57.7	73.2	73.2	88.6	88.6	88.6	104.0	104.3	119.1	119.4	119.4	135.2	135.2	135.2	150.6	150.6	150.6	166.0	166.0	181.4	181.8	189.3	197.0
ft	1,000 lb																							
10	250.4	-	-	-	-	-	-	-	-	-	-	-	-	-	-	-	-	-	-	-	-	-	-	-
11	236.3	169.7	-	-	-	-	-	-	-	-	-	-	-	-	-	-	-	-	-	-	-	-	-	-
13	211.3	169.7	97.0	169.7	-	-	-	-	-	-	-	-	-	-	-	-	-	-	-	-	-	-	-	-
15	191.0	169.7	97.0	169.7	60.6	97.0	122.6	-	-	-	-	-	-	-	-	-	-	-	-	-	-	-	-	-
16	182.3	169.7	97.0	169.5	60.6	97.0	118.1	60.6	97.0	-	-	-	-	-	-	-	-	-	-	-	-	-	-	-
19	159.9	157.5	97.0	154.7	60.6	97.0	110.6	60.6	97.0	72.7	60.9	60.6	-	-	-	-	-	-	-	-	-	-	-	-
23	121.6	120.7	97.0	117.0	60.6	96.9	100.0	60.6	96.9	72.7	58.8	60.6	-	-	-	-	-	-	-	-	-	-	-	-
26	98.4	97.1	97.0	94.0	60.6	94.3	91.9	60.6	90.0	69.4	56.8	60.6	36.3	53.3	55.9	-	-	-	-	-	-	-	-	-
29	81.9	80.8	82.3	77.7	60.6	79.7	77.0	60.6	78.4	65.8	54.6	60.6	36.3	50.5	54.2	32.5	43.0	47.3	-	-	-	-	-	-
33	65.6	64.9	66.2	62.1	60.3	63.6	61.0	60.3	63.2	61.0	51.9	60.2	35.4	46.8	52.8	31.4	41.1	46.2	31.0	33.9	-	-	-	-
39	-	49.2	50.3	46.5	51.6	48.1	45.9	51.2	47.6	47.3	48.7	49.3	32.5	42.3	49.3	28.8	37.6	44.2	28.3	33.5	21.6	26.7	-	-
46	-	37.1	38.2	34.5	39.8	36.0	33.8	39.3	35.8	35.6	39.6	37.4	29.2	38.0	38.0	25.9	34.3	38.9	25.7	31.2	20.7	26.0	22.7	19.3
52	-	-	31.2	27.6	32.5	29.2	27.0	32.1	28.8	28.5	32.3	30.3	26.6	32.8	31.0	23.9	31.7	31.8	23.9	29.2	19.7	25.1	22.0	18.7
59	-	-	24.9	21.6	26.2	22.7	20.9	26.0	22.5	22.3	26.2	24.0	24.0	26.5	24.5	21.8	26.7	25.6	22.0	26.2	18.5	24.2	21.3	17.6
65	-	-	-	-	22.2	18.9	16.9	21.8	18.6	18.2	22.0	20.0	22.2	22.4	20.4	20.2	22.4	21.3	20.8	22.0	17.3	22.0	20.3	16.8
72	-	-	-	-	18.6	15.0	13.3	17.9	14.8	14.6	18.3	16.4	20.3	18.6	16.8	18.7	18.6	17.5	19.4	18.3	16.3	18.3	18.5	16.1
79	-	-	-	-	-	-	-	14.8	11.8	11.5	15.1	13.1	17.5	15.7	13.7	17.3	15.3	14.4	16.6	15.1	14.9	15.3	15.3	14.9
85	-	-	-	-	-	-	-	12.6	9.8	9.5	12.8	11.3	15.3	13.3	11.5	15.5	13.3	12.2	14.4	12.8	14.1	13.1	13.1	13.3
92	-	-	-	-	-	-	-	10.5	7.4	7.0	10.7	9.0	13.1	11.2	9.4	13.1	11.2	10.1	12.0	10.7	12.3	10.7	11.2	11.4
98	-	-	-	-	-	-	-	-	4.9	9.3	7.3	11.7	9.5	7.8	11.7	9.5	8.4	10.4	9.3	10.6	9.3	9.5	9.8	9.8
105	-	-	-	-	-	-	-	-	3.3	7.7	5.5	10.1	7.9	5.7	10.1	7.9	6.8	9.0	7.7	9.2	7.7	7.9	8.1	8.1
111	-	-	-	-	-	-	-	-	-	-	-	8.9	6.7	4.3	9.1	6.9	5.2	7.8	6.3	8.0	6.5	6.7	6.9	6.9
118	-	-	-	-	-	-	-	-	-	-	-	7.7	4.8	2.6	7.7	5.3	3.5	6.6	4.8	6.8	5.0	5.0	5.3	5.3
124	-	-	-	-	-	-	-	-	-	-	-	-	-	-	6.9	4.3	2.5	5.4	3.4	5.6	4.0	4.0	4.3	4.3
131	-	-	-	-	-	-	-	-	-	-	-	-	-	-	5.7	3.1	-	4.0	2.2	4.4	2.6	2.9	3.1	3.1
138	-	-	-	-	-	-	-	-	-	-	-	-	-	-	4.8	-	-	2.8	-	3.5	-	-	-	-
144	-	-	-	-	-	-	-	-	-	-	-	-	-	-	-	-	-	2.0	-	2.6	-	-	-	-

Boom extension sequence %

Tele 1	0	0	0	50	30	50	75	40	67	83	50	70	30	60	80	20	70	85	65	90	50	95	100	100
Tele 2	0	50	50	50	30	50	75	40	67	83	50	70	30	60	80	60	70	85	65	90	100	95	100	100
Tele 3	0	0	50	0	30	50	0	60	67	83	70	70	80	60	70	90	70	70	90	70	100	95	92	100
Tele 4	0	0	0	0	30	0	0	30	0	0	40	20	80	60	35	90	70	55	90	75	100	83	92	100
Tele 5	0	0	0	0	30	0	0	30	0	0	40	20	80	60	35	90	70	55	90	75	100	83	92	100

Lifting capacities main boom in 1,000 lb

61,700 lb

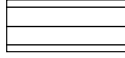

25'1" x 17'9" 360°

85%

		Main boom (ft)																							
Radius (ft)	42.3	57.7	73.2	73.2	88.6	88.6	88.6	104.0	104.3	119.1	119.4	119.4	135.2	135.2	135.2	150.6	150.6	150.6	166.0	166.0	181.4	181.8	189.3	197.0	
ft	1,000 lb																								
10	246.0	-	-	-	-	-	-	-	-	-	-	-	-	-	-	-	-	-	-	-	-	-	-	-	-
11	232.2	169.7	-	-	-	-	-	-	-	-	-	-	-	-	-	-	-	-	-	-	-	-	-	-	-
13	207.5	169.7	97.0	169.7	-	-	-	-	-	-	-	-	-	-	-	-	-	-	-	-	-	-	-	-	-
15	187.5	169.7	97.0	167.9	60.6	97.0	122.6	-	-	-	-	-	-	-	-	-	-	-	-	-	-	-	-	-	-
16	178.9	169.7	97.0	160.4	60.6	97.0	118.1	60.6	97.0	-	-	-	-	-	-	-	-	-	-	-	-	-	-	-	-
19	141.3	139.0	97.0	129.5	60.6	97.0	110.6	60.6	97.0	72.7	60.9	60.6	-	-	-	-	-	-	-	-	-	-	-	-	-
23	98.1	97.0	96.8	93.4	60.6	93.9	90.2	60.6	87.3	72.7	58.8	60.6	-	-	-	-	-	-	-	-	-	-	-	-	-
26	78.7	77.6	79.2	74.5	60.6	76.4	73.4	60.6	74.4	69.4	56.8	60.6	36.3	53.3	55.9	-	-	-	-	-	-	-	-	-	-
29	65.1	64.2	65.6	60.9	60.6	62.9	60.2	60.6	62.3	60.9	54.6	60.6	36.3	50.5	54.2	32.5	43.0	47.3	-	-	-	-	-	-	-
33	51.8	50.9	52.4	48.0	54.2	49.8	47.4	53.5	49.4	49.4	51.6	51.4	35.4	46.7	51.6	31.4	41.1	46.0	31.0	33.9	-	-	-	-	-
39	-	38.0	39.3	35.3	41.1	36.9	34.7	40.4	36.7	36.5	40.5	38.7	32.5	40.9	39.1	28.8	37.6	39.6	28.3	33.5	21.6	26.7	-	-	-
46	-	28.3	29.2	25.7	30.8	27.0	24.8	30.3	26.6	26.6	30.7	28.5	29.2	31.2	29.0	25.9	31.2	29.9	25.7	30.7	20.7	25.9	22.7	19.3	-
52	-	-	23.4	19.8	24.9	21.4	19.2	24.5	20.7	20.7	24.7	22.5	26.6	25.1	22.9	23.9	25.1	24.0	23.9	24.7	19.7	24.5	22.0	18.7	-
59	-	-	18.3	15.0	19.6	16.3	14.3	19.2	15.9	15.4	19.4	17.4	22.0	19.8	17.8	21.8	19.8	18.7	20.9	19.4	18.5	19.6	19.8	17.6	-
65	-	-	-	-	16.4	12.9	10.9	15.7	12.4	12.4	16.2	14.2	18.8	16.6	14.6	18.8	16.6	15.3	17.5	16.2	17.3	16.4	16.4	16.4	-
72	-	-	-	-	13.0	9.9	7.5	12.6	9.5	9.3	12.8	10.8	15.3	13.3	11.5	15.5	13.3	12.2	14.4	12.8	14.6	13.0	13.0	13.3	-
79	-	-	-	-	-	-	-	10.0	6.7	6.5	10.2	8.3	12.7	10.7	8.9	12.9	10.7	9.6	11.8	10.2	12.0	10.5	10.5	10.7	-
85	-	-	-	-	-	-	-	8.2	4.7	4.3	8.4	6.4	10.8	9.1	6.9	11.3	9.1	7.8	10.0	8.4	10.2	8.9	8.9	9.1	-
92	-	-	-	-	-	-	-	6.5	2.6	-	6.7	4.3	9.2	7.2	4.8	9.4	7.2	5.7	8.1	6.7	8.3	6.7	7.0	7.2	-
98	-	-	-	-	-	-	-	-	-	-	5.1	2.7	7.8	5.6	3.2	8.0	5.6	4.2	6.9	5.1	7.1	5.1	5.4	5.6	-
105	-	-	-	-	-	-	-	-	-	-	3.5	-	6.6	4.1	-	6.8	4.1	2.6	5.2	3.5	5.5	3.5	3.9	4.1	-
111	-	-	-	-	-	-	-	-	-	-	-	-	5.4	2.9	-	5.6	2.9	-	4.0	2.3	4.3	2.5	2.7	2.9	-
118	-	-	-	-	-	-	-	-	-	-	-	-	4.4	-	-	4.4	-	-	2.8	-	3.1	-	-	-	-
124	-	-	-	-	-	-	-	-	-	-	-	-	-	-	-	3.4	-	-	-	-	2.2	-	-	-	-
131	-	-	-	-	-	-	-	-	-	-	-	-	-	-	-	2.4	-	-	-	-	-	-	-	-	-

Boom extension sequence %

Tele 1	0	0	0	50	30	50	75	40	67	83	50	70	30	60	80	20	70	85	65	90	50	95	100	100
Tele 2	0	50	50	50	30	50	75	40	67	83	50	70	30	60	80	60	70	85	65	90	100	95	100	100
Tele 3	0	0	50	0	30	50	0	60	67	83	70	70	80	60	70	90	70	70	90	70	100	95	92	100
Tele 4	0	0	0	0	30	0	0	30	0	0	40	20	80	60	35	90	70	55	90	75	100	83	92	100
Tele 5	0	0	0	0	30	0	0	30	0	0	40	20	80	60	35	90	70	55	90	75	100	83	92	100

MAIN MENU

CONTENTS

Lifting capacities main boom in 1,000 lb

37,000 lb

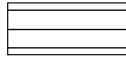

25'1" x 17'9" 360°

85%

		Main boom (ft)																							
Radius (ft)	42.3	57.7	73.2	73.2	88.6	88.6	88.6	104.0	104.3	119.1	119.4	119.4	135.2	135.2	135.2	150.6	150.6	150.6	166.0	166.0	181.4	181.8	189.3	197.0	
ft	1,000 lb																								
10	241.2	-	-	-	-	-	-	-	-	-	-	-	-	-	-	-	-	-	-	-	-	-	-	-	-
11	227.5	169.7	-	-	-	-	-	-	-	-	-	-	-	-	-	-	-	-	-	-	-	-	-	-	-
13	203.3	169.7	97.0	164.6	-	-	-	-	-	-	-	-	-	-	-	-	-	-	-	-	-	-	-	-	-
15	178.1	156.1	97.0	134.3	60.6	97.0	119.1	-	-	-	-	-	-	-	-	-	-	-	-	-	-	-	-	-	-
16	156.8	141.6	97.0	122.3	60.6	97.0	109.1	60.6	99.3	-	-	-	-	-	-	-	-	-	-	-	-	-	-	-	-
19	109.4	105.8	96.6	95.8	60.6	87.5	86.5	60.6	82.1	75.6	60.9	60.6	-	-	-	-	-	-	-	-	-	-	-	-	-
23	72.8	71.7	73.4	67.9	60.6	68.4	65.1	60.5	63.3	58.9	58.8	60.5	-	-	-	-	-	-	-	-	-	-	-	-	-
26	57.6	56.7	58.5	53.6	59.4	55.3	52.4	58.1	53.5	49.9	55.3	52.4	36.3	53.6	50.3	-	-	-	-	-	-	-	-	-	-
29	47.3	46.1	47.8	43.2	49.8	45.1	42.4	48.9	44.5	42.6	48.2	45.1	36.3	46.8	43.7	32.5	43.5	42.3	-	-	-	-	-	-	-
33	37.0	36.0	37.5	33.2	39.3	35.1	32.5	38.7	34.5	34.3	39.1	36.7	35.3	39.1	36.0	31.4	37.6	35.6	31.0	33.7	-	-	-	-	-
39	-	26.3	27.5	23.5	29.0	25.0	22.6	28.6	24.6	24.6	29.0	26.6	31.7	29.4	27.2	28.8	29.3	27.8	28.3	27.5	21.6	26.7	-	-	-
46	-	18.6	19.5	16.0	21.3	17.3	15.1	20.8	16.9	16.9	21.1	18.9	23.9	21.5	19.3	24.1	21.5	20.2	22.6	21.1	20.6	20.6	20.2	19.3	-
52	-	-	15.1	11.8	16.6	12.9	10.9	16.2	12.4	12.4	16.4	14.4	19.3	16.9	14.9	19.3	16.9	15.5	18.0	16.4	18.0	16.6	16.4	16.3	-
59	-	-	11.2	7.5	12.5	9.0	6.6	12.1	8.4	8.1	12.3	10.1	15.0	12.8	10.6	15.0	12.8	11.7	13.9	12.3	14.1	12.5	12.5	12.5	-
65	-	-	-	-	9.9	6.0	3.6	9.5	5.5	5.3	9.7	7.5	12.3	10.1	8.1	12.3	10.1	9.0	11.0	9.7	11.5	9.9	9.9	10.1	-
72	-	-	-	-	7.5	3.1	-	6.9	2.7	2.4	7.1	4.7	9.7	7.5	5.1	9.9	7.5	6.2	8.4	7.1	8.8	7.3	7.3	7.5	-
79	-	-	-	-	-	-	-	4.5	-	-	4.7	2.3	7.6	5.2	3.0	7.8	5.2	3.8	6.7	4.7	6.9	4.9	5.2	5.2	-
85	-	-	-	-	-	-	-	2.9	-	-	3.1	-	6.4	3.6	-	6.4	3.6	-	4.9	3.1	5.1	3.1	3.3	3.6	-
92	-	-	-	-	-	-	-	-	-	-	-	-	4.6	-	-	4.8	-	-	3.0	-	3.4	-	-	-	-
98	-	-	-	-	-	-	-	-	-	-	-	-	3.3	-	-	3.4	-	-	-	-	-	-	-	-	-
105	-	-	-	-	-	-	-	-	-	-	-	-	-	-	-	2.4	-	-	-	-	-	-	-	-	-

Boom extension sequence %

Tele 1	0	0	0	50	30	50	75	40	67	83	50	70	30	60	80	20	70	85	65	90	50	95	100	100
Tele 2	0	50	50	50	30	50	75	40	67	83	50	70	30	60	80	60	70	85	65	90	100	95	100	100
Tele 3	0	0	50	0	30	50	0	60	67	83	70	70	80	60	70	90	70	70	90	70	100	95	92	100
Tele 4	0	0	0	0	30	0	0	30	0	0	40	20	80	60	35	90	70	55	90	75	100	83	92	100
Tele 5	0	0	0	0	30	0	0	30	0	0	40	20	80	60	35	90	70	55	90	75	100	83	92	100

MAIN MENU

CONTENTS

Lifting capacities main boom in 1,000 lb

Special boom extension sequence

37,000 lb

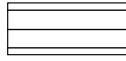

25'1" x 17'9"

360°

85%

Radius	Main boom (ft)					
	88.6 ft	104.3 ft	119.1 ft	135.2 ft	150.6 ft	166.0 ft
ft	1,000 lb					
15	55.7	-	-	-	-	-
16	55.7	56.3	-	-	-	-
19	52.8	51.9	38.8	-	-	-
23	48.9	46.4	38.7	-	-	-
26	46.2	43.0	36.3	21.8	-	-
29	43.6	39.8	34.1	21.8	21.8	-
33	40.5	36.2	31.4	21.8	21.8	21.8
39	33.2	31.8	28.1	21.8	21.8	21.8
46	25.0	25.7	25.0	21.5	21.8	21.5
52	20.2	21.1	21.2	19.5	20.1	19.5
59	16.1	16.7	17.0	17.2	16.3	15.4
65	13.2	13.9	14.3	14.6	13.5	12.8
72	10.6	11.5	11.7	11.9	10.8	10.2
79	-	9.4	9.6	9.8	8.9	8.1
85	-	7.7	8.2	8.4	7.5	6.8
92	-	6.5	6.8	7.0	6.1	5.2
98	-	-	5.8	5.8	4.9	4.0
105	-	-	4.6	4.8	3.5	2.6
111	-	-	-	4.0	2.7	-
118	-	-	-	2.8	-	-

Boom extension sequence %



Tele 1	0	0	0	0	0	0
Tele 2	0	0	0	0	50	100
Tele 3	50	67	83	100	100	100
Tele 4	50	67	83	100	100	100
Tele 5	50	67	83	100	100	100

[MAIN MENU](#)

[CONTENTS](#)

Lifting capacities main boom in 1,000 lb

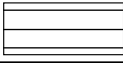
Special boom extension sequence

12,300 lb   25'1" x 17'9" 360° 85%

Radius	Main boom (ft)					
	88.6 ft	104.3 ft	119.1 ft	135.2 ft	150.6 ft	166.0 ft
ft	1,000 lb					
15	55.7	-	-	-	-	-
16	55.7	56.3	-	-	-	-
19	52.8	51.9	38.8	-	-	-
23	48.8	46.4	38.7	-	-	-
26	44.4	43.0	36.3	21.8	-	-
29	37.0	37.5	34.1	21.8	21.8	-
33	29.0	30.1	30.6	21.8	21.8	21.7
39	21.6	22.3	22.7	21.8	21.4	19.7
46	15.3	16.2	16.7	16.9	16.0	14.9
52	12.1	12.6	13.0	13.3	12.4	11.7
59	9.0	9.5	9.9	10.1	9.2	8.4
65	7.0	7.6	7.9	8.1	7.2	6.5
72	5.1	5.7	6.2	6.4	5.3	4.4
79	-	4.1	4.5	4.7	3.4	2.5
85	-	2.7	3.1	3.3	2.2	-

Boom extension sequence %

Tele 1	0	0	0	0	0	0
Tele 2	0	0	0	0	50	100
Tele 3	50	67	83	100	100	100
Tele 4	50	67	83	100	100	100
Tele 5	50	67	83	100	100	100

[MAIN MENU](#)

[CONTENTS](#)

Notes to lifting capacity

Lifting capacities do not exceed 85% of tipping load.

Weight of hook blocks and slings are part of the load, and are to be deducted from the capacity ratings.

Crane operation is permissible up to a

wind speed of 32 ft/s

Consult operation manual for further details on wind speed.

All capacities above the parting line are based on structural strength. Capacities below the parting line are based on machine stability.

Crane operation is subject to computer charts, only!

For crane operations consult operation manual first!

Working range main boom extension

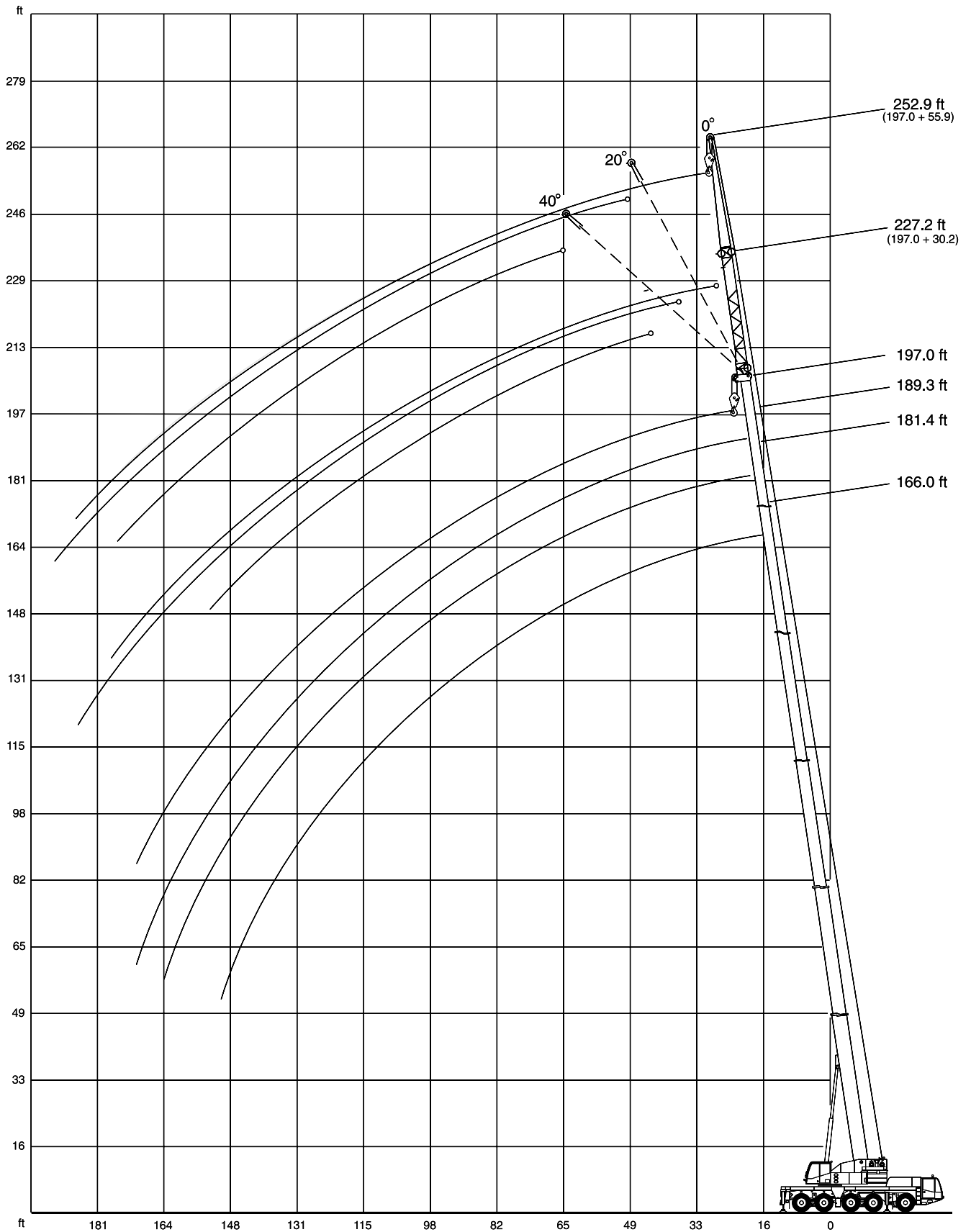



[MAIN MENU](#)

[CONTENTS](#)



Lifting capacities main boom extension in 1,000 lb

Main boom: 166.0 ft

83,800 lb   25'1" x 24'7" 360° 85%



Radius ft	Extension					
	30.2 ft			55.9 ft		
	0°	20°	40°	0°	20°	40°
ft	1,000 lb					
46	19.8	-	-	-	-	-
52	18.8	-	-	9.2	-	-
59	17.4	13.0	11.4	8.8	-	-
65	16.6	13.0	11.4	8.4	6.6	-
72	15.4	12.7	11.2	8.1	6.6	-
79	14.5	12.5	10.7	7.9	6.3	5.5
85	13.9	12.1	10.5	7.5	6.1	5.5
92	12.9	11.8	10.3	7.2	5.7	5.5
98	12.3	11.4	10.1	6.8	5.5	5.5
105	11.6	10.8	9.9	6.6	5.2	5.2
111	11.2	10.6	9.7	6.4	5.2	5.2
118	10.3	10.1	9.4	6.1	5.0	5.0
124	9.7	9.7	9.0	5.7	5.0	5.0
131	8.4	9.2	8.8	5.5	4.8	4.8
138	7.0	7.6	8.1	5.2	4.8	4.8
144	6.2	6.6	-	5.0	4.6	4.6
151	5.0	5.5	-	4.8	4.6	4.6
157	4.2	4.6	-	4.6	4.4	4.4
164	3.0	3.5	-	4.4	4.4	4.4
170	2.4	2.9	-	3.4	4.4	-
177	1.7	-	-	2.6	3.5	-
184	-	-	-	2.1	2.6	-
190	-	-	-	-	2.2	-

Main boom: 189.3 ft

83,800 lb   25'1" x 24'7" 360° 85%



Radius ft	Extension					
	30.2 ft			55.9 ft		
	0°	20°	40°	0°	20°	40°
ft	1,000 lb					
46	-	-	-	-	-	-
52	12.5	-	-	-	-	-
59	12.3	-	-	7.0	-	-
65	12.1	-	-	7.0	-	-
72	11.9	10.3	10.1	6.8	-	-
79	11.4	10.3	10.1	6.6	5.5	-
85	10.8	9.9	9.9	6.6	5.3	-
92	10.3	9.6	9.4	6.3	5.2	5.0
98	9.9	9.2	9.2	6.1	5.0	5.0
105	9.4	8.8	9.0	5.7	4.8	5.0
111	9.0	8.4	8.4	5.5	4.8	4.8
118	8.8	7.9	7.9	5.5	4.6	4.8
124	8.2	7.7	7.7	5.3	4.6	4.6
131	7.7	7.2	7.2	5.0	4.6	4.6
138	7.2	7.0	6.8	4.8	4.4	4.6
144	6.2	6.6	6.6	4.6	4.4	4.4
151	5.0	5.7	6.3	4.4	4.1	4.4
157	4.2	4.9	-	4.4	4.1	4.2
164	3.3	3.9	-	4.1	4.1	4.1
170	2.7	3.1	-	3.3	3.9	4.1
177	2.0	2.4	-	2.6	3.5	3.9
184	-	1.7	-	1.9	2.8	-
190	-	-	-	-	2.2	-

Main boom: 181.8 ft

83,800 lb   25'1" x 24'7" 360° 85%

Radius ft	Extension					
	30.2 ft			55.9 ft		
	0°	20°	40°	0°	20°	40°
ft	1,000 lb					
46	16.0	-	-	-	-	-
52	15.2	-	-	8.1	-	-
59	14.5	-	-	7.9	-	-
65	13.7	11.6	10.8	7.5	-	-
72	12.8	11.6	10.8	7.2	5.7	-
79	12.1	11.2	10.5	7.0	5.7	-
85	11.7	10.6	10.3	6.8	5.5	5.2
92	11.2	10.3	9.9	6.6	5.5	5.2
98	10.6	9.9	9.7	6.4	5.3	5.2
105	10.1	9.4	9.4	6.1	5.0	5.0
111	9.7	9.2	9.0	5.7	5.0	5.0
118	9.2	8.8	8.8	5.7	4.8	4.8
124	8.8	8.4	8.4	5.5	4.8	4.8
131	8.1	7.9	7.9	5.2	4.6	4.8
138	7.2	7.4	7.7	5.0	4.6	4.6
144	6.2	6.8	7.2	4.8	4.4	4.6
151	5.0	5.7	-	4.6	4.4	4.4
157	4.2	4.9	-	4.4	4.2	4.4
164	3.3	3.9	-	4.1	4.1	4.4
170	2.7	3.1	-	3.3	4.1	4.2
177	2.0	2.2	-	2.6	3.5	-
184	-	-	-	2.1	2.8	-
190	-	-	-	-	2.2	-

Main boom: 197.0 ft

83,800 lb   25'1" x 24'7" 360° 85%

Radius ft	Extension					
	30.2 ft			55.9 ft		
	0°	20°	40°	0°	20°	40°
ft	1,000 lb					
46	-	-	-	-	-	-
52	11.2	-	-	-	-	-
59	10.8	-	-	6.6	-	-
65	10.6	-	-	6.4	-	-
72	10.3	9.4	9.7	6.3	-	-
79	10.1	9.4	9.6	6.1	4.6	-
85	9.9	9.2	9.2	6.1	4.6	-
92	9.4	8.8	9.0	5.7	4.6	4.8
98	9.2	8.4	8.4	5.5	4.6	4.8
105	9.0	8.1	8.1	5.2	4.6	4.8
111	8.4	7.7	7.7	5.0	4.6	4.6
118	7.9	7.4	7.4	5.0	4.6	4.6
124	7.7	7.1	7.1	4.8	4.4	4.6
131	7.2	6.8	6.8	4.6	4.4	4.6
138	6.8	6.6	6.6	4.4	4.4	4.4
144	6.4	6.1	6.4	4.4	4.2	4.4
151	5.2	5.7	5.7	4.1	4.1	4.1
157	4.4	5.1	-	3.9	3.9	4.1
164	3.3	4.1	-	3.9	3.9	4.1
170	2.7	3.1	-	3.3	3.5	3.9
177	2.0	2.4	-	2.6	3.5	3.9
184	-	1.7	-	2.1	2.8	-
190	-	-	-	-	2.2	-

Lifting capacities main boom extension in 1,000 lb

Main boom: 166.0 ft

61,700 lb  25'1" x 24'7" 360° 85%

Radius ft	Extension					
	30.2 ft			55.9 ft		
	0°	20°	40°	0°	20°	40°
ft	1,000 lb					
46	19.8	-	-	-	-	-
52	18.8	-	-	9.2	-	-
59	17.4	13.0	11.4	8.8	-	-
65	16.6	13.0	11.4	8.4	6.6	-
72	15.4	12.7	11.2	8.1	6.6	-
79	14.5	12.5	10.7	7.9	6.3	5.5
85	13.9	12.1	10.5	7.5	6.1	5.5
92	12.9	11.8	10.3	7.2	5.7	5.5
98	12.1	11.4	10.1	6.8	5.5	5.5
105	10.1	10.8	9.9	6.6	5.2	5.2
111	8.5	9.7	9.7	6.4	5.2	5.2
118	7.0	7.9	8.8	6.1	5.0	5.0
124	5.6	6.7	7.2	5.7	5.0	5.0
131	4.4	5.3	5.7	5.5	4.8	4.8
138	3.2	4.1	4.5	4.3	4.8	4.8
144	2.4	3.1	-	3.5	4.6	4.6
151	1.7	2.1	-	2.6	3.9	4.6
157	-	-	-	2.0	2.9	3.6
164	-	-	-	-	2.2	2.6
170	-	-	-	-	-	-

Main boom: 189.3 ft

61,700 lb  25'1" x 24'7" 360° 85%

Radius ft	Extension					
	30.2 ft			55.9 ft		
	0°	20°	40°	0°	20°	40°
ft	1,000 lb					
46	-	-	-	-	-	-
52	12.5	-	-	-	-	-
59	12.3	-	-	7.0	-	-
65	12.1	-	-	7.0	-	-
72	11.9	10.3	10.1	6.8	-	-
79	11.4	10.3	10.1	6.6	5.5	-
85	10.8	9.9	9.9	6.6	5.3	-
92	10.3	9.6	9.4	6.3	5.2	5.0
98	9.9	9.2	9.2	6.1	5.0	5.0
105	9.4	8.8	9.0	5.7	4.8	5.0
111	8.8	8.4	8.4	5.5	4.8	4.8
118	7.0	7.9	7.9	5.5	4.6	4.8
124	5.8	6.9	7.5	5.3	4.6	4.6
131	4.6	5.5	6.2	5.0	4.6	4.6
138	3.5	4.3	4.8	4.3	4.4	4.6
144	2.6	3.3	4.0	3.3	4.4	4.4
151	1.7	2.4	2.8	2.6	3.9	4.4
157	-	-	-	1.8	2.9	4.0
164	-	-	-	-	2.2	2.8
170	-	-	-	-	-	2.2

Main boom: 181.8 ft

61,700 lb  25'1" x 24'7" 360° 85%

Radius ft	Extension					
	30.2 ft			55.9 ft		
	0°	20°	40°	0°	20°	40°
ft	1,000 lb					
46	16.0	-	-	-	-	-
52	15.2	-	-	8.1	-	-
59	14.5	-	-	7.9	-	-
65	13.7	11.6	10.8	7.5	-	-
72	12.8	11.6	10.8	7.2	5.7	-
79	12.1	11.2	10.5	7.0	5.7	-
85	11.7	10.6	10.3	6.8	5.5	5.2
92	11.2	10.3	9.9	6.6	5.5	5.2
98	10.6	9.9	9.7	6.4	5.3	5.2
105	10.1	9.4	9.4	6.1	5.0	5.0
111	8.9	9.2	9.0	5.7	5.0	5.0
118	7.0	8.1	8.8	5.7	4.8	4.8
124	5.8	6.9	7.4	5.5	4.8	4.8
131	4.6	5.5	6.2	5.2	4.6	4.8
138	3.5	4.3	4.8	4.3	4.6	4.6
144	2.6	3.3	3.6	3.3	4.4	4.6
151	1.7	2.4	-	2.6	3.9	4.4
157	-	-	-	2.0	2.9	4.0
164	-	-	-	-	2.2	2.8
170	-	-	-	-	-	2.0

Main boom: 197.0 ft

61,700 lb  25'1" x 24'7" 360° 85%

Radius ft	Extension					
	30.2 ft			55.9 ft		
	0°	20°	40°	0°	20°	40°
ft	1,000 lb					
46	-	-	-	-	-	-
52	11.2	-	-	-	-	-
59	10.8	-	-	6.6	-	-
65	10.6	-	-	6.4	-	-
72	10.3	9.4	9.7	6.3	-	-
79	10.1	9.4	9.6	6.1	4.6	-
85	9.9	9.2	9.2	6.1	4.6	-
92	9.4	8.8	9.0	5.7	4.6	4.8
98	9.2	8.4	8.4	5.5	4.6	4.8
105	9.0	8.1	8.1	5.2	4.6	4.8
111	8.4	7.7	7.7	5.0	4.6	4.6
118	7.2	7.4	7.4	5.0	4.6	4.6
124	6.2	7.1	7.1	4.8	4.4	4.6
131	4.8	5.5	6.4	4.6	4.4	4.6
138	3.5	4.5	5.0	4.3	4.4	4.4
144	2.6	3.3	4.0	3.5	4.2	4.4
151	1.9	2.6	2.8	2.6	4.1	4.1
157	-	1.8	-	2.0	3.1	3.9
164	-	-	-	-	2.2	3.0
170	-	-	-	-	-	2.2

Lifting capacities main boom extension in 1,000 lb

Main boom: 166.0 ft

37,000 lb  25'1" x 24'7" 360° 85%

Radius ft	Extension					
	30.2 ft			55.9 ft		
	0°	20°	40°	0°	20°	40°
ft	1,000 lb					
46	19.8	-	-	-	-	-
52	18.8	-	-	9.2	-	-
59	17.4	13.0	11.4	8.8	-	-
65	16.6	13.0	11.4	8.4	6.6	-
72	15.4	12.7	11.2	8.1	6.6	-
79	12.6	12.5	10.7	7.9	6.3	5.5
85	10.4	12.1	10.5	7.5	6.1	5.5
92	8.1	9.6	10.3	7.2	5.7	5.5
98	6.5	7.8	8.9	6.8	5.5	5.5
105	4.8	6.1	6.8	5.7	5.2	5.2
111	3.4	4.7	5.4	4.7	5.2	5.2
118	2.2	3.1	3.9	3.3	5.0	5.0
124	-	2.0	2.7	2.3	4.2	5.0
131	-	-	-	-	2.9	4.2
138	-	-	-	-	1.9	2.8
144	-	-	-	-	-	2.0

Main boom: 189.3 ft

37,000 lb  25'1" x 24'7" 360° 85%

Radius ft	Extension					
	30.2 ft			55.9 ft		
	0°	20°	40°	0°	20°	40°
ft	1,000 lb					
46	-	-	-	-	-	-
52	12.5	-	-	-	-	-
59	12.3	-	-	7.0	-	-
65	12.1	-	-	7.0	-	-
72	11.9	10.3	10.1	6.8	-	-
79	11.4	10.3	10.1	6.6	5.5	-
85	10.4	9.9	9.9	6.6	5.3	-
92	8.1	9.6	9.4	6.3	5.2	5.0
98	6.7	8.0	9.0	6.1	5.0	5.0
105	4.8	6.3	7.2	5.7	4.8	5.0
111	3.6	4.9	5.6	4.7	4.8	4.8
118	2.4	3.3	4.2	3.1	4.6	4.8
124	-	2.3	3.0	2.2	4.2	4.6
131	-	-	2.0	-	2.9	4.4
138	-	-	-	-	1.9	3.0
144	-	-	-	-	-	2.2

Main boom: 181.8 ft

37,000 lb  25'1" x 24'7" 360° 85%

Radius ft	Extension					
	30.2 ft			55.9 ft		
	0°	20°	40°	0°	20°	40°
ft	1,000 lb					
46	16.0	-	-	-	-	-
52	15.2	-	-	8.1	-	-
59	14.5	-	-	7.9	-	-
65	13.7	11.6	10.8	7.5	-	-
72	12.8	11.6	10.8	7.2	5.7	-
79	12.0	11.2	10.5	7.0	5.7	-
85	10.4	10.6	10.3	6.8	5.5	5.2
92	8.1	9.8	9.9	6.6	5.5	5.2
98	6.7	8.0	9.0	6.4	5.3	5.2
105	4.8	6.3	7.2	5.7	5.0	5.0
111	3.6	4.7	5.6	4.7	5.0	5.0
118	2.4	3.3	4.2	3.3	4.8	4.8
124	-	2.3	3.0	2.3	4.2	4.8
131	-	-	1.8	-	2.9	4.2
138	-	-	-	-	1.9	3.0
144	-	-	-	-	-	2.2

Main boom: 197.0 ft

37,000 lb  25'1" x 24'7" 360° 85%

Radius ft	Extension					
	30.2 ft			55.9 ft		
	0°	20°	40°	0°	20°	40°
ft	1,000 lb					
46	-	-	-	-	-	-
52	11.2	-	-	-	-	-
59	10.8	-	-	6.6	-	-
65	10.6	-	-	6.4	-	-
72	10.3	9.4	9.7	6.3	-	-
79	10.1	9.4	9.6	6.1	4.6	-
85	9.9	9.2	9.2	6.1	4.6	-
92	8.3	8.8	9.0	5.7	4.6	4.8
98	6.9	7.9	8.4	5.5	4.6	4.8
105	5.0	6.3	7.2	5.2	4.6	4.8
111	3.6	4.9	5.8	4.4	4.6	4.6
118	2.4	3.5	4.4	3.3	4.6	4.6
124	-	2.5	3.2	2.3	4.2	4.6
131	-	-	2.0	-	3.1	4.4
138	-	-	-	-	1.9	3.0
144	-	-	-	-	-	2.2

Lifting capacities main boom extension in 1,000 lb

Main boom: 166.0 ft

83,800 lb  25'1" x 17'9" 360° 85%

Radius ft	Extension					
	30.2 ft			55.9 ft		
	0°	20°	40°	0°	20°	40°
ft	1,000 lb					
46	19.8	-	-	-	-	-
52	18.8	-	-	9.2	-	-
59	17.4	13.0	11.4	8.8	-	-
65	16.6	13.0	11.4	8.4	6.6	-
72	15.4	12.7	11.2	8.1	6.6	-
79	14.5	12.5	10.7	7.9	6.3	5.5
85	13.7	12.1	10.5	7.5	6.1	5.5
92	11.6	11.8	10.3	7.2	5.7	5.5
98	10.0	10.8	10.1	6.8	5.5	5.5
105	8.1	9.2	9.9	6.6	5.2	5.2
111	7.1	7.8	8.5	6.4	5.2	5.2
118	5.5	6.6	7.0	6.1	5.0	5.0
124	4.5	5.4	5.8	5.5	5.0	5.0
131	3.3	4.2	4.6	4.4	4.8	4.8
138	2.3	3.0	3.2	3.2	4.8	4.8
144	-	2.2	-	2.4	4.0	4.6
151	-	-	-	1.7	2.8	3.5
157	-	-	-	-	2.2	2.5
164	-	-	-	-	-	1.7

Main boom: 189.3 ft

83,800 lb  25'1" x 17'9" 360° 85%

Radius ft	Extension					
	30.2 ft			55.9 ft		
	0°	20°	40°	0°	20°	40°
ft	1,000 lb					
46	-	-	-	-	-	-
52	12.5	-	-	-	-	-
59	12.3	-	-	7.0	-	-
65	12.1	-	-	7.0	-	-
72	11.9	10.3	10.1	6.8	-	-
79	11.4	10.3	10.1	6.6	5.5	-
85	10.8	9.9	9.9	6.6	5.3	-
92	10.3	9.6	9.4	6.3	5.2	5.0
98	9.9	9.2	9.2	6.1	5.0	5.0
105	8.3	8.8	9.0	5.7	4.8	5.0
111	7.3	8.0	8.4	5.5	4.8	4.8
118	5.7	6.8	7.5	5.5	4.6	4.8
124	4.7	5.6	6.5	5.3	4.6	4.6
131	3.5	4.4	4.9	4.4	4.6	4.6
138	2.4	3.2	3.9	3.2	4.3	4.6
144	1.8	2.4	2.9	2.4	3.9	4.4
151	-	-	1.9	1.7	2.8	3.9
157	-	-	-	-	2.2	2.9
164	-	-	-	-	-	2.2

Main boom: 181.8 ft

83,800 lb  25'1" x 17'9" 360° 85%

Radius ft	Extension					
	30.2 ft			55.9 ft		
	0°	20°	40°	0°	20°	40°
ft	1,000 lb					
46	16.0	-	-	-	-	-
52	15.2	-	-	8.1	-	-
59	14.5	-	-	7.9	-	-
65	13.7	11.6	10.8	7.5	-	-
72	12.8	11.6	10.8	7.2	5.7	-
79	12.1	11.2	10.5	7.0	5.7	-
85	11.7	10.6	10.3	6.8	5.5	5.2
92	11.2	10.3	9.9	6.6	5.5	5.2
98	10.0	9.9	9.7	6.4	5.3	5.2
105	8.3	9.4	9.4	6.1	5.0	5.0
111	7.3	8.0	8.8	5.7	5.0	5.0
118	5.7	6.8	7.3	5.7	4.8	4.8
124	4.7	5.6	6.2	5.5	4.8	4.8
131	3.3	4.4	4.8	4.4	4.6	4.8
138	2.4	3.2	3.9	3.2	4.6	4.6
144	1.8	2.4	2.7	2.4	4.0	4.6
151	-	-	-	1.7	2.8	3.9
157	-	-	-	-	2.2	2.9
164	-	-	-	-	-	2.2

Main boom: 197.0 ft

83,800 lb  25'1" x 17'9" 360° 85%

Radius ft	Extension					
	30.2 ft			55.9 ft		
	0°	20°	40°	0°	20°	40°
ft	1,000 lb					
46	-	-	-	-	-	-
52	11.2	-	-	-	-	-
59	10.8	-	-	6.6	-	-
65	10.6	-	-	6.4	-	-
72	10.3	9.4	9.7	6.3	-	-
79	10.1	9.4	9.6	6.1	4.6	-
85	9.9	9.2	9.2	6.1	4.6	-
92	9.4	8.8	9.0	5.7	4.6	4.8
98	9.2	8.4	8.4	5.5	4.6	4.8
105	8.8	8.1	8.1	5.2	4.6	4.8
111	7.4	7.7	7.7	5.0	4.6	4.6
118	6.1	7.0	7.4	5.0	4.6	4.6
124	4.9	5.8	6.5	4.8	4.4	4.6
131	3.5	4.6	5.1	4.4	4.4	4.6
138	2.6	3.2	4.1	3.2	4.3	4.4
144	1.8	2.4	2.9	2.4	3.9	4.4
151	-	1.7	2.1	1.7	3.0	4.1
157	-	-	-	-	2.2	3.1
164	-	-	-	-	-	2.2

Lifting capacities main boom extension in 1,000 lb

Main boom: 166.0 ft

61,700 lb  25'1" x 17'9" 360° 85%

Radius ft	Extension					
	30.2 ft			55.9 ft		
	0°	20°	40°	0°	20°	40°
ft	1,000 lb					
46	19.8	-	-	-	-	-
52	18.8	-	-	9.2	-	-
59	17.4	13.0	11.4	8.8	-	-
65	16.6	13.0	11.4	8.4	6.6	-
72	13.7	12.7	11.2	8.1	6.6	-
79	11.1	12.4	10.7	7.9	6.3	5.5
85	9.3	10.4	10.5	7.5	6.1	5.5
92	7.4	8.7	9.4	7.2	5.7	5.5
98	5.8	7.1	8.0	6.8	5.5	5.5
105	4.4	5.5	6.6	5.5	5.2	5.2
111	3.1	4.3	4.9	4.3	5.2	5.2
118	2.0	2.8	3.5	3.1	4.8	5.0
124	-	2.0	2.5	2.0	3.6	5.0
131	-	-	-	-	2.6	4.0
138	-	-	-	-	1.7	2.6
144	-	-	-	-	-	1.8

Main boom: 189.3 ft

61,700 lb  25'1" x 17'9" 360° 85%

Radius ft	Extension					
	30.2 ft			55.9 ft		
	0°	20°	40°	0°	20°	40°
ft	1,000 lb					
46	-	-	-	-	-	-
52	12.5	-	-	-	-	-
59	12.3	-	-	7.0	-	-
65	12.1	-	-	7.0	-	-
72	11.9	10.3	10.1	6.8	-	-
79	11.3	10.3	10.1	6.6	5.5	-
85	9.5	9.9	9.9	6.6	5.3	-
92	7.6	9.0	9.4	6.3	5.2	5.0
98	6.2	7.3	8.0	6.1	5.0	5.0
105	4.6	5.7	6.8	5.5	4.8	5.0
111	3.4	4.5	5.4	4.3	4.8	4.8
118	2.2	3.1	3.9	2.8	4.6	4.8
124	-	2.2	2.7	2.0	4.0	4.6
131	-	-	1.7	-	2.6	3.9
138	-	-	-	-	1.7	2.8
144	-	-	-	-	-	2.0

Main boom: 181.8 ft

61,700 lb  25'1" x 17'9" 360° 85%

Radius ft	Extension					
	30.2 ft			55.9 ft		
	0°	20°	40°	0°	20°	40°
ft	1,000 lb					
46	16.0	-	-	-	-	-
52	15.2	-	-	8.1	-	-
59	14.5	-	-	7.9	-	-
65	13.7	11.6	10.8	7.5	-	-
72	12.8	11.6	10.8	7.2	5.7	-
79	11.3	11.2	10.5	7.0	5.7	-
85	9.5	10.6	10.3	6.8	5.5	5.2
92	7.6	8.7	9.6	6.6	5.5	5.2
98	6.2	7.3	8.0	6.4	5.3	5.2
105	4.6	5.7	6.6	5.5	5.0	5.0
111	3.2	4.5	5.4	4.3	5.0	5.0
118	2.2	3.1	3.9	3.1	4.8	4.8
124	-	2.0	2.7	2.0	4.0	4.8
131	-	-	1.7	-	2.6	4.0
138	-	-	-	-	1.7	2.8
144	-	-	-	-	-	2.0

Main boom: 197.0 ft

61,700 lb  25'1" x 17'9" 360° 85%

Radius ft	Extension					
	30.2 ft			55.9 ft		
	0°	20°	40°	0°	20°	40°
ft	1,000 lb					
46	-	-	-	-	-	-
52	11.2	-	-	-	-	-
59	10.8	-	-	6.6	-	-
65	10.6	-	-	6.4	-	-
72	10.3	9.4	9.7	6.3	-	-
79	10.1	9.4	9.6	6.1	4.6	-
85	9.5	9.2	9.2	6.1	4.6	-
92	7.6	8.7	9.0	5.7	4.6	4.8
98	6.4	7.5	8.2	5.5	4.6	4.8
105	4.8	6.1	6.8	5.2	4.6	4.8
111	3.4	4.7	5.4	4.2	4.6	4.6
118	2.2	3.3	4.2	3.1	4.6	4.6
124	-	2.3	3.0	2.0	4.0	4.6
131	-	-	2.0	-	2.9	4.2
138	-	-	-	-	1.9	2.8
144	-	-	-	-	-	2.0

Lifting capacities main boom extension in 1,000 lb

Special boom extension sequence

Main boom: 166.0 ft

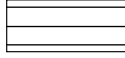

25'1" x 24'7" 360°

85%

Extension						
Radius	83,800 lb	61,700 lb	37,000 lb	83,800 lb	61,700 lb	37,000 lb
		30.2 ft			55.9 ft	
0°						
ft	1,000 lb					
46	14.5	14.5	14.5	-	-	-
52	14.5	14.5	14.5	6.6	6.6	6.6
59	13.6	13.6	13.6	6.6	6.6	6.6
65	12.8	12.8	12.8	6.6	6.6	6.6
72	12.1	12.1	12.1	6.3	6.3	6.3
79	11.4	11.4	11.4	6.1	6.1	6.1
85	10.6	10.6	10.6	6.1	6.1	6.1
92	9.9	9.9	9.9	5.7	5.7	5.7
98	9.5	9.5	9.0	5.5	5.5	5.5
105	9.0	9.0	7.4	5.2	5.2	5.2
111	8.4	8.4	6.2	5.0	5.0	5.0
118	7.9	7.9	4.8	5.0	5.0	5.0
124	7.5	7.5	4.0	4.8	4.8	4.6
131	7.0	7.0	2.9	4.6	4.6	3.5
138	6.6	6.1	1.9	4.4	4.4	2.6
144	6.4	5.1	-	4.4	4.4	2.0
151	6.1	4.1	-	4.1	4.1	-
157	5.5	3.3	-	3.9	3.9	-
164	5.2	2.6	-	3.5	3.3	-
170	5.0	2.0	-	3.3	2.7	-
177	4.4	-	-	3.0	2.2	-
184	-	-	-	2.8	-	-
190	-	-	-	2.6	-	-
197	-	-	-	2.1	-	-
203	-	-	-	1.9	-	-

[MAIN MENU](#)

[CONTENTS](#)

Lifting capacities main boom extension in 1,000 lb

Special boom extension sequence

Main boom: 166.0 ft

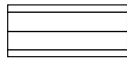

25'1" x 17'9" 360°

85%

Extension						
Radius	83,800 lb	61,700 lb	37,000 lb	83,800 lb	61,700 lb	37,000 lb
		30.2 ft			55.9 ft	
0°						
ft	1,000 lb					
46	14.5	14.5	-	-	-	-
52	14.5	14.5	-	6.6	6.6	-
59	13.6	13.6	-	6.6	6.6	-
65	12.8	12.8	-	6.6	6.6	-
72	12.1	12.1	-	6.3	6.3	-
79	11.4	11.4	-	6.1	6.1	-
85	10.6	10.6	-	6.1	6.1	-
92	9.9	9.6	-	5.7	5.7	-
98	9.5	8.2	-	5.5	5.5	-
105	9.0	6.8	-	5.2	5.2	-
111	8.4	5.8	-	5.0	5.0	-
118	7.9	4.6	-	5.0	5.0	-
124	6.9	3.6	-	4.8	4.4	-
131	5.7	2.6	-	4.6	3.3	-
138	4.8	-	-	4.4	2.6	-
144	4.2	-	-	4.4	-	-
151	3.0	-	-	3.9	-	-
157	2.4	-	-	3.1	-	-
164	-	-	-	2.6	-	-

[MAIN MENU](#)

[CONTENTS](#)

Technical description

Carrier

Drive/steering	10 x 6 x 8
Frame	Monobox main frame with outrigger boxes integral, of high-strength fine grain structural steel.
Outriggers	Four hydraulically telescoping outrigger beams with hydraulic jack legs.
Engine	Mercedes Benz OM 442 LA water-cooled 8-cylinder engine (EURO I), output to DIN: 370 kW (503 hp) at 2100 1/min max. torque 2020 Nm at 1100-1600 1/min. Fuel tank capacity: 500 l.
Transmission	ZF Transmatik system (14 ranges), transfer case with longitudinal differential lockout control.
Axles	Axle 1: steering; axle 2: with planetary hubs, steering, transverse differential lockout control; axle 3: rigid axle, non-steer; axle 4: with planetary hubs, steering, longitudinal and transverse differential lockout control; axle 5: with planetary hubs, steering, transverse differential lockout control.
Suspension	Hydropneumatic suspension, all axles hydraulically blockable.
Wheels and tyres	10 wheels fitted with 14.00 R 25 tyres, single wheels on all axles.
Steering	ZF dual-circuit semiblock mechanical steering with hydraulic booster.
Brakes	Service brake: dual-line air system. Parking brake: spring-loaded type, on 2nd, 4th and 5th axles. Sustained action brake: constant decompression with butterfly valve, exhaust brake and hydraulic retarder.
Electrical equipment	24 V system.
Driver's cab	Rubber-mounted all steel driver's cab with safety glazing, slide-by side windows, controls and instrumentation, driver's and mate's seat, vertically adjustable steering wheel, heated outside mirrors, rotaflare warning light.

Superstructure

Engine	Mercedes Benz OM 366 A water-cooled 6-cylinder in-line engine (EURO I), output 112 kW (153 hp) at 2200 1/min, max. torque 540 Nm at 1400 1/min, fuel tank capacity: 200 l.
Hydraulic system	1 variable displacement axial piston pump to provide 4 simultaneous, independent working movements and separate pump for slew unit.
Hoist	Fixed displacement axial piston hydraulic motor, hoist drum with integral planetary gear reducer and spring-applied multi-disk. Drum rotation indicator.
Slew unit	Hydraulic motor with planetary gear reducer, change-over from brake to free swing by control lever, spring-applied holding brake.
Boom elevation	1 differential cylinder with automatic lowering brake valve.
Crane cab	Spacious all-steel comfortable cab with sliding door and large hinged windscreen, tiltable 20°; roof window with armoured glass, full instrumentation and crane controls, working light. Hot water heater operated either self-contained or engine-dependent, with engine preheating and timer, thermostat-controlled. Windscreen washer and intermittent control type windscreen wiper.
Main boom	Boom base and 5 telescopic sections, fabricated from fine grain structural steel, telescoping ability with partial load, buckling-resistant Demag ovaloid design.
Counterweight	61,700 lb, self removable.
Safety devices	Electronic safe load indicator with digital readout for hook load, rated load, boom length, boom angle, load radius, analog display to indicate the capacity utilization, limit switches on hoist and lowering motions, pressure-relief and safety holding valves.
Hydraulic servo control	Hydro-electric pilot control through self-centering control levers.

Optional equipment

Drive/steering	10 x 8 x 8
Wheels and tyres	16.00 R 25 on 11.25-25 rims; 20.5 R 25 on 17.00-25 rims.
Tow coupling	D-value 12 t or 19 t, air-brake connection.
Hoist II	Fixed displacement axial piston hydraulic motor, hoist drum with integral planetary gear reducer and spring-applied multi-disk brake. The use of hoist II avoids re-reeving the hoist line when using the optional jib.
Main boom extension	Side-folding 1 or 2-part jib, 30 ft or 56 ft. 0°, 20° and 40° offset.
Additional counterweight	22,000 lb, integrates into standard counterweight, installed hydraulically by the crane itself.